

ASK 41.4 2U

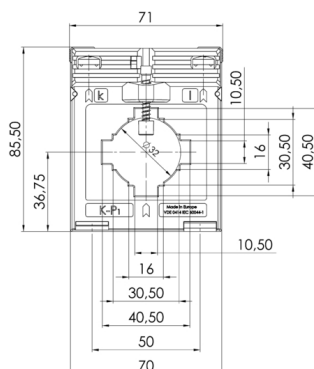

PB_ASK41.4_online-zoom.jpg



TZ_ASK41.4_F_online-zoom.jpg

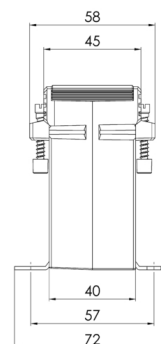

TZ_ASK41.4_S_online-zoom.jpg

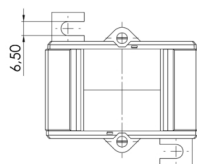

TZ_ASK41.4_T_online-zoom.jpg

Description

Secondary change-over plug-in current transformer for primary nominal currents from 200-100 A up to 1000-500 A, secondary nominal current 5 A or 1 A (optional 2 A), accuracy class 1 (optional in class 0.5s and 0.5).

Technical Data

- Therm. nominal continuous current I_{cth} : $1,0 \times I_N$
- Therm. nominal short-time current I_{th} : $60 \times I_N$, 1 sec.
- Max. operating voltage U_m : 0.72 kV
- Isolation test voltage: 3 kV, U_{eff} , 50 Hz, 1 min.
- Nominal rated frequency: 50...60 Hz
- Isolation class: E
- Bus bar 1: 40 x 10 mm
- Bus bar 2: 2 x 30 x 5 mm
- Round conductor: 32 mm
- Width: 71 mm
- Height: 85,5 mm
- Depth: 58 mm